



# Tower USER MANUAL

**HV Battery System**  
Tower -T7/T10/T14/T17/T21  
192 - 576V

# Contents

Statement of Law .....	1
Revision History .....	1
Safety Handling Guide of Lithium Batteries .....	2
1 Introduction .....	4
Brief Introduction .....	4
Product Properties .....	4
Symbol Definition .....	4
Abbreviations in the Document .....	6
2 Product Specifications .....	7
System Performance Parameter .....	7
Battery Module .....	8
Battery Controller .....	12
3 Installation and Configuration .....	15
Environmental Requirements .....	15
Installation Spacing Requirements .....	15
Installation Location Precautions .....	16
Tools .....	16
Safety Gear .....	17
Unpacking .....	17
Equipment Installation .....	19
4 Maintenance .....	24
Trouble shooting .....	24
Replacement of Main Components .....	24
Battery Maintenance .....	25
5 Storage Recommendations .....	27
6 Shipment .....	27

## Statement of Law

Copyright of this document belongs to Dy Ness Digital Energy Technology Co., LTD.  
No part of this documentation is to be excerpted, reproduced, translated, annotated or duplicated in any form or by any means without the prior written authorization of Dy Ness Digital Energy Technology Co., LTD.

This product complies with the design requirements of environmental protection and personal safety. The storage, use and disposal of the products shall be carried out in accordance with the product manual, relevant contract or relevant laws and regulations. Customers can check the related information on the Dy Ness Digital Energy Technology Co., LTD. website when the product or technology is updated.

URL: <http://www.dyness.com/>

Please note that the product can be modified without prior notification.

### Revision History

Revision No.	Revision Date	Revision Reason
1.0	2019.09.11	First Published.
2.0	2020.03.03	Structural design changed.
3.0	2020.06.28	Parameters changed.
3.1	2020.09.28	<ol style="list-style-type: none"> <li>1. Connector of the power cable changed.</li> <li>2. Color of Wake button changed.</li> <li>3. A negative output point and a module positive point on the composite plug of the module, and a negative output point and a module negative point on the composite socket of the module were added.</li> <li>4. A positive output point and a negative output point on the composite socket of BDU were added.</li> <li>5. Battery nameplate and module label were updated.</li> </ol>
3.2	2021.03.02	<ol style="list-style-type: none"> <li>1. System performance parameters were updated.</li> <li>2. Installation spacing requirements were updated.</li> <li>3. Installation location precautions were updated.</li> <li>4. Grounding was updated.</li> </ol>
3.3	2021.03.15	Adaptive functions were upgraded.
3.4	2022.06.10	Website was updated.

## Safety Handling Guide of Lithium Batteries

### DANGER

Before installation or operation carefully read the "Tower ESS User Manual".

The batteries will produce high voltage DC power and might cause lethal voltage and electric shock.

Only qualified persons are allowed to wire the batteries.

### WARNING

This product is a high voltage DC system, and should be operated by authorized persons only.

Risk of battery system damage or personal injury.

DO NOT disconnect while the system is running!

Keep all power sources off and verify that they are de-energized.

Battery damage may result in electrolyte leakage. If the electrolyte is leaked, do not touch the leaked electrolyte or volatile gas, and contact the after-sales service team for help immediately. If leaked material was touched accidentally, please follow the steps below:

- Inhalation of leaked material: Evacuate from contaminated area and seek medical assistance immediately.
- Eye contact: Flush with clean water for at least 15 minutes and seek medical assistance immediately.
- Skin contact: Wash the contact area thoroughly with soap and clean water and seek medical assistance immediately.
- Ingestion: Induce vomiting and seek immediate medical assistance.
- Do not move the battery system if it is connected with an external expansion module.

If you need to replace or add a battery, please contact the after-sales service center.

### CAUTION

Risk of battery system failure or life cycle reduction.

#### **Before Connecting**

Please check product and packing list after unpacking. If the product is damaged or parts are missing, please contact the local dealer.

Before installation, make sure that the grid is disconnected and the battery is switched off.

Do not invert the positive and negative cables and ensure there is no short circuit to the external device.

It is prohibited to connect the battery to AC power directly.

The battery system must be properly grounded and the resistance must be less than 1Ω.

Ensure that the electrical parameters of the battery system are compatible with the respective equipment.

Keep the battery away from water and fire.

#### **During Use**

If the battery system needs to be moved or repaired, the power must be disconnected and the battery must be switched off.

It is prohibited to connect different types of batteries.

It is prohibited to connect the battery to incompatible or faulty inverters.

It is prohibited to disassemble the battery (to avoid the warranty sticker to be removed or damaged).

In case of fire, only a dry powder fire extinguisher must be used, foam extinguishers are prohibited.

Please do not open, repair or disassemble batteries; this is reserved for Dyness staff or authorized personnel. We do not take any responsibility caused by violation of safety operation or equipment safety standards.

#### **Maintenance**

Please read the user manual carefully.

If batteries are stored for a long time, it is required to charge them every six months, and the SOC should be no less than 80%.

Batteries need to be recharged within 12 hours, after being fully discharged.

Do not expose cables outside.

All battery terminals must be disconnected for maintenance.

Please contact the supplier within 24 hours if there is something abnormal.

Warranty claims are excluded for direct or indirect damage due to items above.

# 1 Introduction

## Brief Introduction

Tower is a high voltage battery energy storage system based on lithium iron phosphate batteries, and it is one of the new products developed and produced by Dyness. They are used to provide reliable power for various types of equipment and systems. Tower is especially suitable for high power, limited installation space, restricted load-bearing and long cycle life.

## Product Properties

The entire module is non-toxic, non-polluting and environment-friendly.

The anode material is made from LiFePO4 with high security and long cycle life.

The Battery Management System (BMS) comes with protective functions including over-discharge, over-charge, over-current and high/low temperature.

The system automatically manages charging and discharging and balances current and voltage of each cell.

Flexible configuration, multiple battery modules can be connected in series for expanding voltage and capacity.

The adopted self-cooling mode rapidly reduces the system noise.

The module has less self-consumption, does not need to be charged up to 6 months; no memory effect, excellent performance of shallow charging and discharging.

The operating temperature range is 0 to +50°C, with excellent discharging performance and cycle life.

Small size and light weight, easy installation and maintenance of standard module.

## Symbol Definition

DYNESS ENERGY STORAGE SYSTEM					
	T7	T10	T14	T17	T21
Nominal Energy/kWh	7.1	10.7	14.2	17.8	21.3
Nominal Voltage/V	192	288	384	480	576
Nominal Capacity/Ah	37	37	37	37	37
Ambient Temp/°C	0-50	0-50	0-50	0-50	0-50
IP Grade	54	54	54	54	54
Protective Class	I	I	I	I	I

WWW.DYNESS-TECH.COM  
 DAQIN NEW ENERGY TECH (CHONGQI) CO., LTD

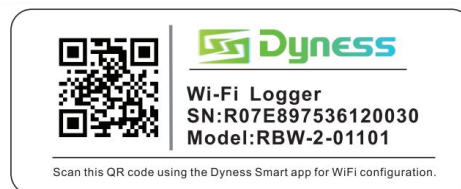



Figure 1-1 Battery energy storage system nameplate

Table 1-1 Symbol Definition

	Battery voltage is higher than safe voltage. Be careful of electric shock.
	Be careful with your actions and be aware of the dangers.
	Read the user manual before use.
	Do not dispose of batteries with the household waste; it must be recycled environmentally-friendly.
	At the end of the life cycle, batteries can continue to be used after being recycled. Please do not discard illegally.
	This product meets European directive requirements.
	This product passed the TUV certification.



---

Product Name: **HV9637**

Module: **LFP Lithium Ion Battery**

Capacity/Voltage: **37Ah/96V**



Total Storing Energy: **3.552kWh**

Charge Voltage: **105~108V**

Max. Discharge Power: **3.5kW**

Series Number:

Manufacture Date:

[www.dyness-tech.com](http://www.dyness-tech.com)

DAQIN NEW ENERGY TECH(TAIZHOU) CO.,LTD

Figure 1-2 Battery module label

## Abbreviations in the Document

Table 1-2 Abbreviations in the document

Abbreviations in this document	Full name
BDU	Battery Disconnect Unit
BMS	Battery Management System
SOC	State Of Charge
PCS	Number of battery modules
DOD	Depth of discharge
NC	Normally closed



## 2 Product Specifications

### System Performance Parameter

Table 2-1 Tower system parameters

Model	T21	T17	T14	T10	T7
Cell technology	LFP	LFP	LFP	LFP	LFP
Total energy stored [kWh]	21.31	17.76	14.21	10.66	7.10
Usable energy [kWh]	21.31	17.76	14.21	10.66	7.10
Recommend depth of discharge	95%	95%	95%	95%	95%
Max depth of discharge	100%	100%	100%	100%	100%
Module configuration	6 series	5 series	4 series	3 series	2 series
Voltage range [V/DC]	504~657	420~547	336~438	252~328	168~219
Battery system voltage (V/DC)	576	480	384	288	192
Battery system capacity (Ah)	37	37	37	37	37
Battery system charge voltage (V/DC)	657	547.5	438	328.5	219
Battery system charge current [A] (standard)	7.4	7.4	7.4	7.4	7.4
Battery system charge current [A] (normal)	18.5	18.5	18.5	18.5	18.5
Battery system charge current [A] (max)	37	37	37	37	37
Battery system discharge minimum voltage (V/DC)	504	420	336	252	168
Battery system discharge current [A] (standard)	7.4	7.4	7.4	7.4	7.4
Battery system discharge current [A] (normal)	18.5	18.5	18.5	18.5	18.5
Battery system discharge current [A] (max)	37	37	37	37	37
Battery system max charge & discharge current [A] (in communication with	22.5	22.5	22.5	22.5	22.5

Model	T21	T17	T14	T10	T7
inverter)					
Discharge temperature [°C]	-10~50	-10~50	-10~50	-10~50	-10~50
Charge temperature [°C]	0~50	0~50	0~50	0~50	0~50
Max discharge power [kW]	21.31	17.76	14.21	10.66	7.1
Max charge & discharge power [kW] (in communication with inverter)	12.78	10.65	8.52	6.39	4.2
Short circuit current [kA]	1.5	1.5	1.5	1.5	1.5
IP protection class	IP54	IP54	IP54	IP54	IP54
Dimensions [mm]	504*1500* 380	504*1300* 380	504*1100* 380	504*900* 380	504*700* 380
Weight [kg]	269	228	187	146	105
Battery module name	HV9637	HV9637	HV9637	HV9637	HV9637
Number of battery modules (pcs)	6	5	4	3	2

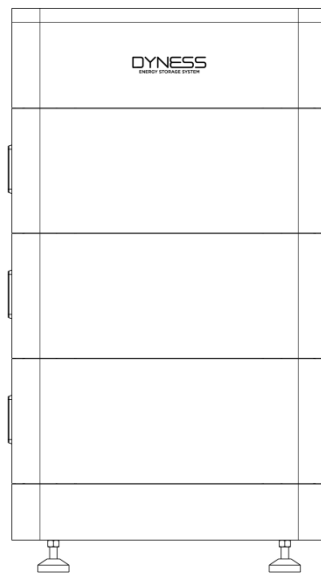

Figure 2-1 Tower T10

### Battery Module

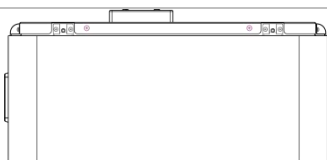

Figure 2-2 Battery module

Table 2-2 Product parameters

Module name	HV9637
Cell technology	Li-ion (LFP)
Battery module energy (kWh)	3.552
Battery module voltage (V/DC)	96
Battery module capacity (Ah)	37
Number of battery module cells (pcs)	30
Battery cell power (Wh)	118.4
Battery cell voltage (V/DC)	3.2
Battery cell capacity (Ah)	37
Number of battery module cells in series (pcs)	30
Battery module charge voltage (V/DC)	109.5
Battery module charge current (normal) [A]	18.5
Battery module charge current (max) [A]	37
Battery module discharge minimum voltage (V/DC)	84
Battery system discharge current (standard) [A]	7.4
Battery module discharge current (normal) [A]	18.5
Battery module discharge current (max) [A]	37
Dimensions (W*D*H, mm)	380*504*240
Communication mode	CAN/RS485
Pollution degree (PD)	II
Operating temperature (°C)	0~50
IP protection class	IP54
Weight (kg)	41

Composite connector - Plug

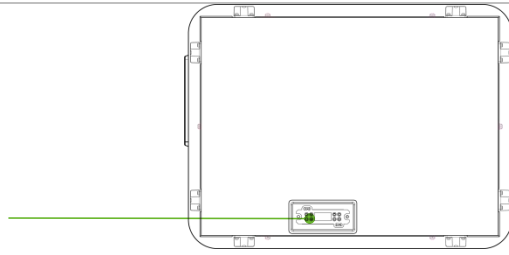

Figure 2-3 HV9637 connections on top

Composite connector-Socket

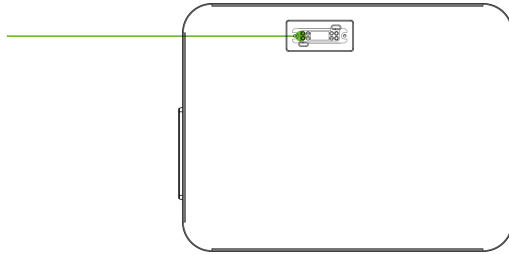

Figure 2-4 HV9637 connections at bottom

Table 2-3 Interface Definition

Name	Definition
Composite connector - Plug	Battery module output and communication interface
Composite connector - Socket	Battery module output and communication interface

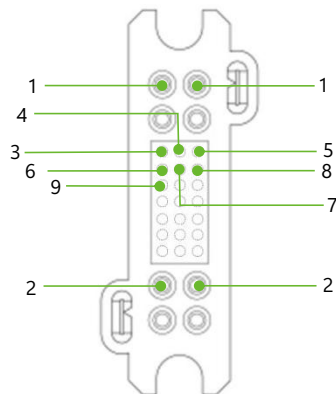

Figure 2-5 Composite Connector-Plug

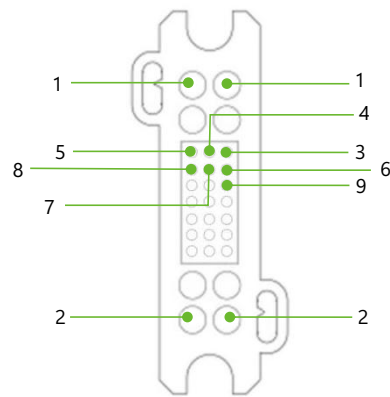

Figure 2-6 Composite Connector-Socket

Table 2-4 Port definition

No.	Composite connector - Plug	Composite connector - Socket
1	Negative output	Negative output
2	Module positive	Module negative
3	SWAKE	SWAKE
4	SCANSG	SCANSG
5	SCANL	SCANL
6	SCANH	SCANH
7	24V-	24V-
8	24V+	24V+
9	SCANIN	SCANOUT

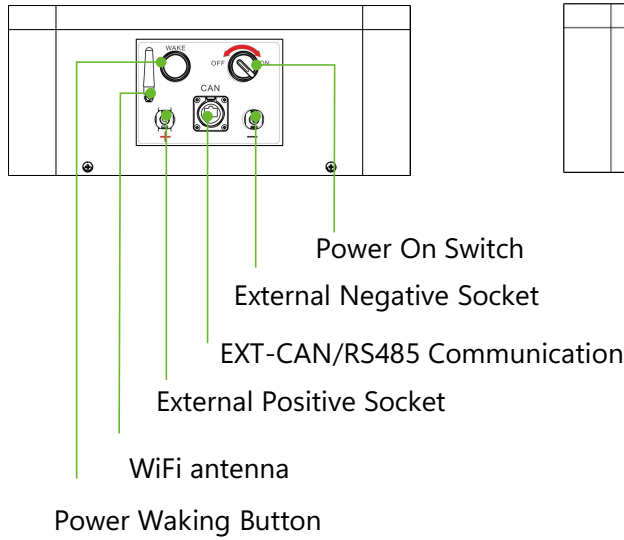

Figure 2-7 BDU right connections

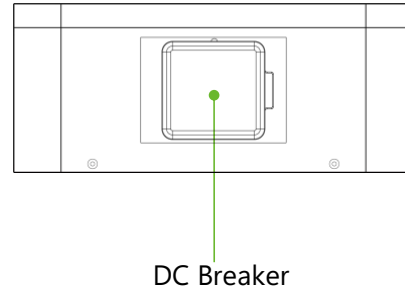

Figure 2-8 BDU left connections

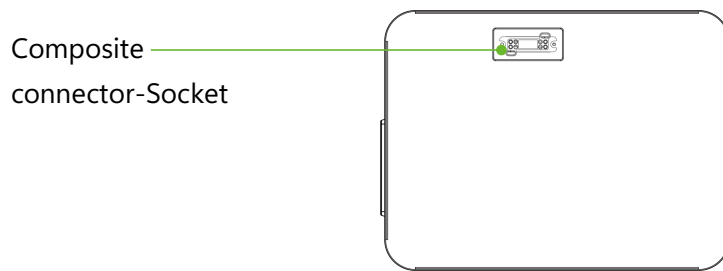

Figure 2-9 BDU bottom connections

Table 2-5 Interface Definition

Name	Description
WAKE button	Press and hold 10s to start the battery system
External positive socket	Connect battery system to inverter positive terminal
EXT-CAN/RS485 communication port	RJ45 communication port between battery system and inverter
External negative socket	Connect battery system to inverter negative terminal
ON/OFF switch	Switch on to start the BMS system
DC breaker	Master switch of the battery system: Switch on before switching ON/OFF and WAKE buttons on; short circuit protection.

Name	Description
Composite connector - Socket	Battery module output and communication interface
WiFi antenna	Receiving and sending WiFi signals.

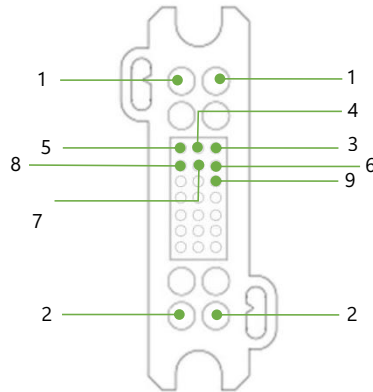

Figure 2-10 ON/OFF switch



DO NOT switch off during normal operation.

Table 2-6 Port definition

No.	Definition
1	Negative output
2	Positive output
3	SWAKE
4	SCANSG
5	SCANL
6	SCANH
7	24V-
8	24V+
9	SCANOUT



Ensure ON/OFF switch is turned on before waking up the battery. Otherwise it will affect the auto test process and cause danger.

DO NOT switch off the ON/OFF switch during normal operation, only in emergencies.

Otherwise it will cause the battery current to surge.

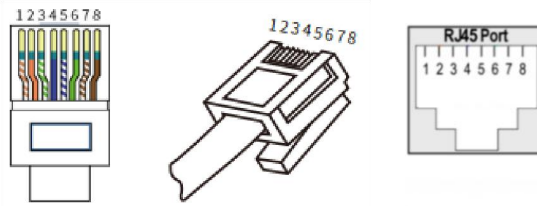

Figure 2-11 EXT-CAN/RS485 pin definition

**CAUTION**

If the DC breaker trips because of over-current or short circuit, you must wait for 30 minutes to switch it on again, otherwise it may cause damage to the breaker.

Table 2-7 EXT-CAN/RS485 pin definition

PIN	Color	Definition
PIN1	Orange/White	485_A
PIN2	Orange	485_B
PIN3	Green/White	Reserved
PIN4	Blue	CANH
PIN5	Blue/White	CANL
PIN6	Green	CANIN
PIN7	Brown/White	CANOUT
PIN8	Brown	NC



## 3 Installation and Configuration

### Environmental Requirements



#### Cleanliness

The battery system has high voltage connectors. The environmental conditions will affect the isolation of the system.

Before installation and switch-on, dust and swarf must be removed to keep the system clean. The environment must be dust-proof to a certain extent.

Dust and humidity must be regularly checked during continuous operation of the system.

#### Fire Protection System

The room must be equipped with a fire protection system or fire extinguishers (Recommended: foam extinguisher). The fire protection system needs to be regularly checked to ensure its normal condition. Please refer to your local fire protection equipment for use and maintenance requirements.

#### Grounding System

Make sure that the grounding point for the battery system is stable and reliable before installation. If the battery system is installed in an independent equipment cabin (e.g. container), make sure that the grounding of the cabin is stable and reliable.

The resistance of the grounding system must be  $\leq 100\text{m}\Omega$ .



#### Temperature

Tower system operating temperature range:  $0^{\circ}\text{C}$  to  $+50^{\circ}\text{C}$ ; Optimal temperature:  $18^{\circ}\text{C}$  to  $30^{\circ}\text{C}$ ; Exceeding the working temperature range will cause over-temperature/under-temperature alarms or protection of the battery system which may lead to shortening the life cycle.

#### Cooling System

It is essential to equip a cooling system to keep the battery system in a relevant temperature range. Over-temperature/ under-temperature alarms or protection of the battery system may lead to shortening the life cycle.

#### Heating System

It is essential to equip a heating system to keep the battery system in a relevant temperature range. If the temperature is below  $0^{\circ}\text{C}$ , the system may shut down for protection. It is necessary to open the heating system first. Exceeding or falling below the operating temperature range will cause over-temperature/under-temperature alarms or protection of the battery system may lead to shortening the life cycle.

### Installation Spacing Requirements



Please note that the battery should be installed with a minimum safe clearance from the surrounding equipment or battery. Please refer to the minimum clearance diagram below.

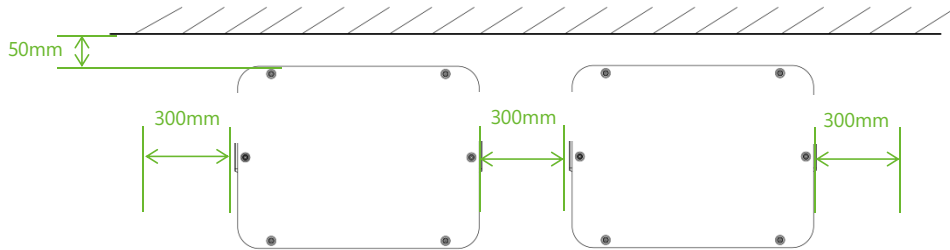

Figure 3-1 Minimum spacing

Installation Location Precautions

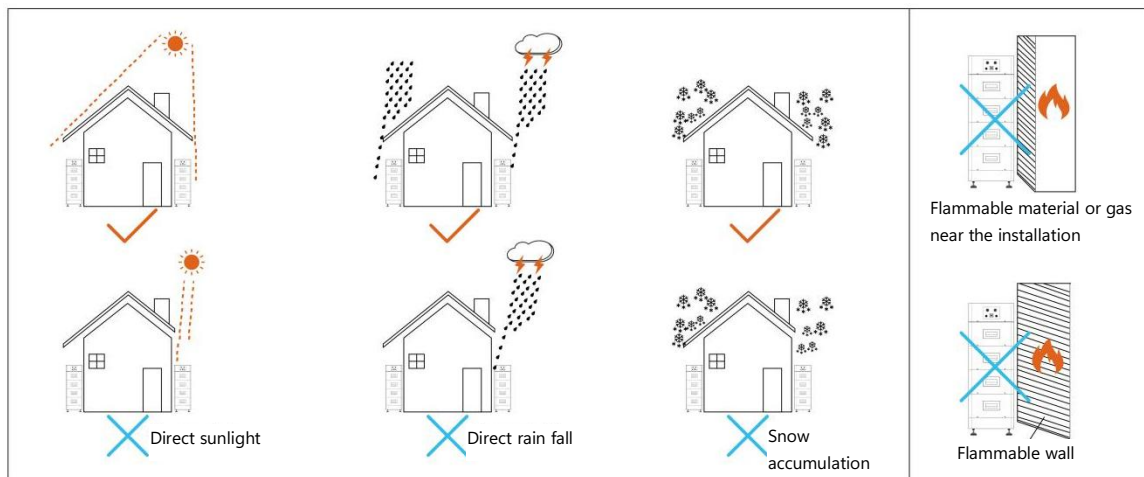

Figure 3-2 Installation location

Tools

The following tools are required to install the battery pack:

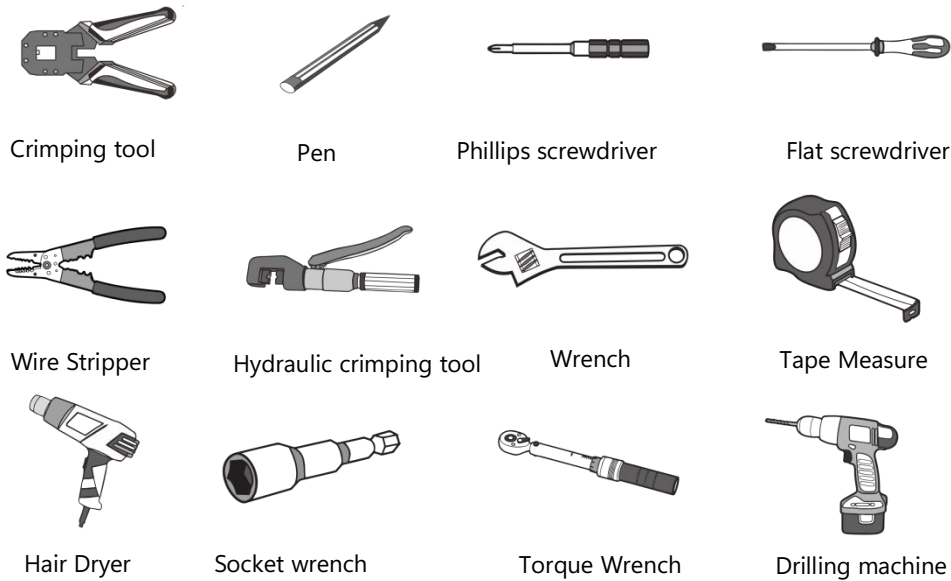

Figure 3-3 Installation tools



Use properly insulated tools to prevent electric shock or short circuit.

### Safety Gear

We recommend wearing the following safety gear when working with batteries:



Figure 3-4 Safety gear

### Unpacking









When the battery system is delivered at the installation site, unloading should be performed according to the rules and regulations, to prevent being exposed to direct sunlight. Batteries should not be installed in locations in direct sunlight. See Figure 3-2 Installation location precautions.

Before unpacking, the total number of boxes must be reconciled according to the shipping list attached to each package, and the boxes must be checked for good condition.

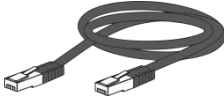
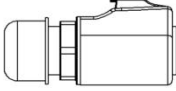
Handle all items carefully and protect the surface coating of the items.

After opening the boxes, the installer should read the technical documentation, verify the list, ensure that the items are complete and undamaged according to the configuration table and packing list. If there is damage to the internal packaging, it should be checked and recorded in detail.

Table 3-1 Packing list

Item	Specifications	Quantity	Image
Tower BDU	504*380*156.5 mm	1 pcs	
Battery module HV9637	96V/37Ah 504*380*240mm	4 pcs	
Tower base	504*380*186 mm	1 pcs	
Communication cable to inverter	Standard, black /L 2000mm /RJ45 plug at both sides	1 pcs	
Communication connector to BDU	RJ45 waterproof connector	1 pcs	
Cross recessed countersunk head screw	M4*10	20 pcs	
M6 3 sets of combination screws	M6*14	1 pcs	
Terminal	OT4-6	2 pcs	
User Manual	30 pages	1 pcs	
Power cable connector	To positive battery pole	1 pcs	

Power cable connector	To negative battery pole	1 pcs	
Power cable	Positive cable 6mm <sup>2</sup> , red, 2m	1 pcs	
Power cable	Negative cable 6mm <sup>2</sup> , black, 2m	1 pcs	

### Equipment Installation

#### Installation Preparation

1. Make sure that the environment meets all technical requirements.
2. Prepare equipment and tools for installation.
3. Confirm that the DC breaker is in OFF position.

#### Mechanical Installation

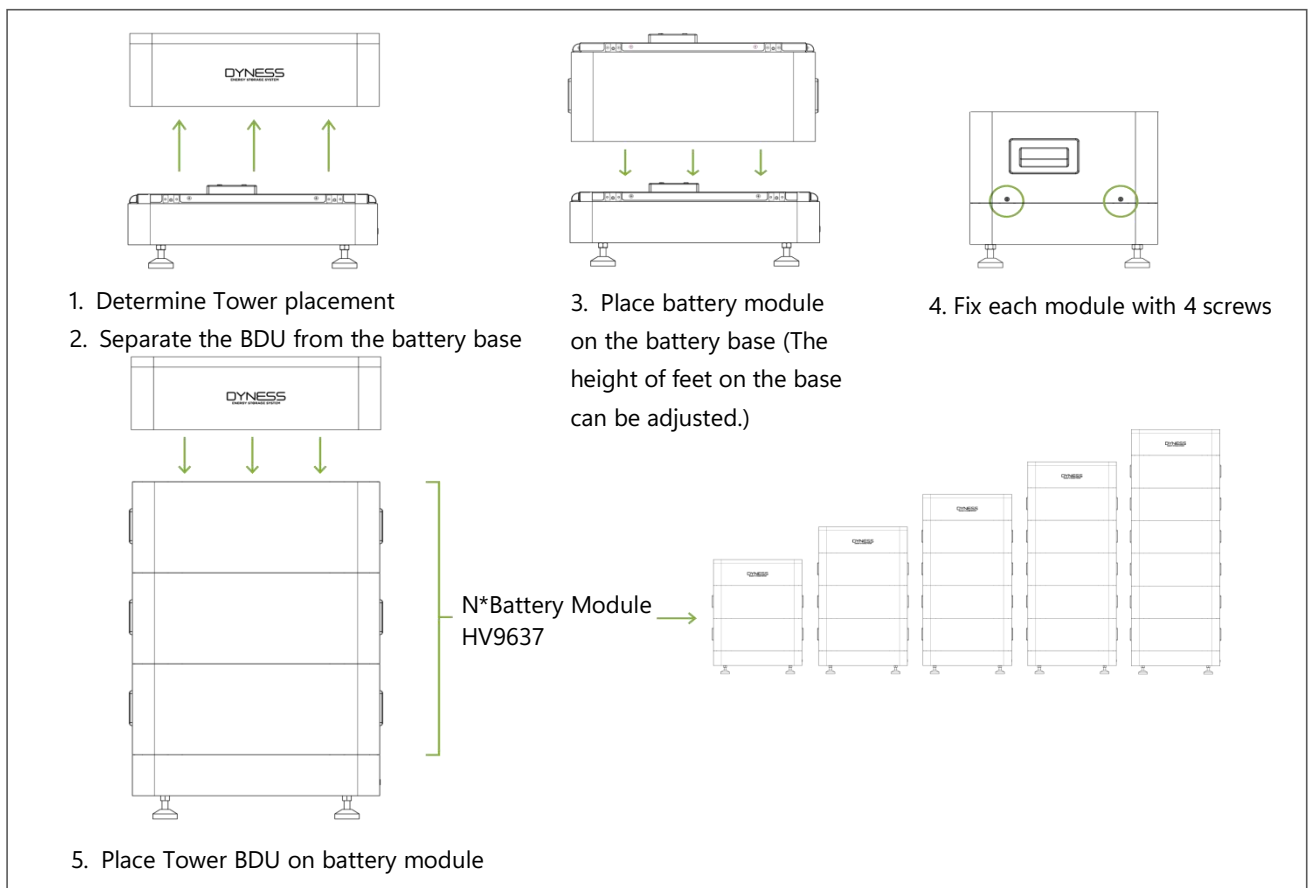

Figure 3-5 Mechanical installation

**DANGER**

The battery system is a high voltage DC system. Ensure that the grounding surface of Tower is stable and reliable.

Please confirm that the battery system is switched off before connecting. Electric shock and damage to the inverter may be caused if the battery is connected directly without being switched off.

Otherwise, the system cannot work properly. The voltage of the battery is too high, please pay attention to self-protection during measurement.

**WARNING**

A single battery module weighs 41kg. It is necessary to install battery modules with helpers if no lifting equipment is available, even more so if the battery modules are installed higher up.

Double check all the power and communication cables. Make sure that the voltage of the inverter is at the same level as the battery system.

- Switch on the inverter, and make sure that all power equipment is working normally.
- Start the battery system. See Table 3-2 Battery system self-test step 2.

Table 3-2 Battery system self-test

### Step 1 Electrical installation

#### Battery system grounding

(After the HV9637 module is stacked, it is fixed with two screws each left and right. Then the shell surfaces of the upper and lower modules are screwed together. There is a special docking point at the bottom of the battery base. See bottom right.)

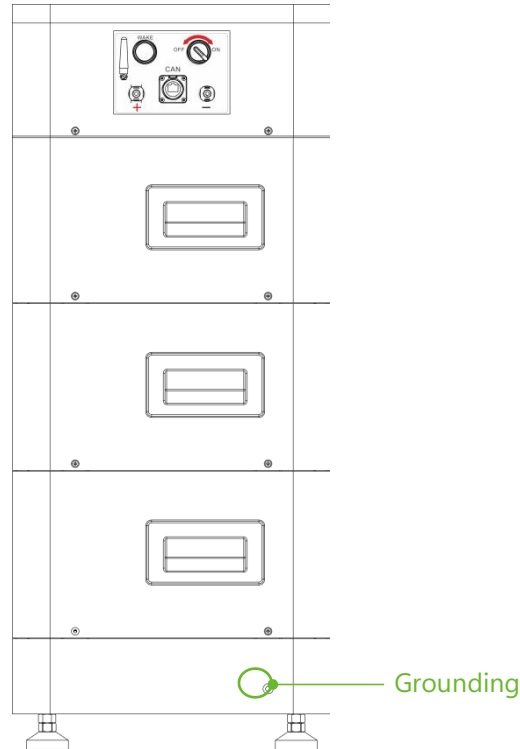

### Step 2 Battery system self-test

1. Switch the DC breaker of the BDU on.

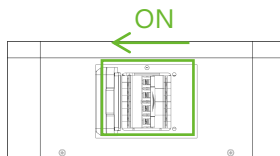

2. Switch the ON/OFF switch on

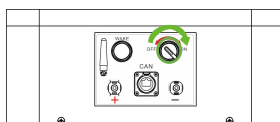

3. Press and hold the WAKE button for approx. 10s.



4. Check the system output voltage.
  - Use a multimeter to measure the output voltage on the positive and negative ports of the BDU.
  - The output voltage should be in the voltage range as shown in "Table 2-1 Tower system parameters".

5. Switch the ON/OFF switch off.



6. Switch the BDU DC BREAKER to OFF position.

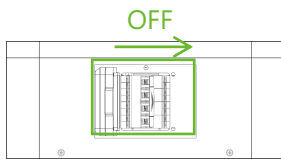

### Step 3 Connecting inverter

1. Connect the external power cable to the inverter

(If the 2m power cable is too short, please use a power cable with same specifications with max 3m length.)



Connect to inverter  
DC+ terminal

Connect to inverter  
DC- terminal

2. Connect the EXT-CAN/RS485 communication cable to the inverter RJ45 CAN/RS485 port.

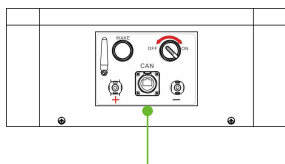

Connect to inverter RJ45 CAN/RS485 communication port



A white warning icon consisting of a triangle with an exclamation mark inside, set against a yellow background.**CAUTION**

We recommend an external DC breaker operating both positive and negative conductors simultaneously between BDU and inverter. After waking up the BDU and ensuring that the BDU is pre-charged, it can be switched on.

## 4 Maintenance

### Trouble shooting

 **DANGER**

The battery system is a high voltage DC system. Must make sure that the grounding surface of Tower is stable and reliable.

Please confirm that the battery system is switched off before connecting. Electric shock and damage to the inverter may be caused if the battery is connected to the inverter directly without being powered off.

Otherwise, the system cannot operate properly. The voltage of the battery is too high, please pay attention to self-protection during measurement.

No.	Problem	Possible Reason	Solution
1	The battery has no voltage output, and "POWER ON"/"POWER WAKE" LEDs are off.	The BDU DC breaker is not switched on.	Switch the BDU DC breaker on.
		The ON/OFF switch of the BDU is not switched on.	Switch the ON/OFF switch on.
		Battery is in sleep mode.	Press and hold the WAKE button for approx. 10s.
		The fuse in the BDU is faulty.	Replace the fuse.
		Battery changes into over-discharged protection.	Charge the battery to leave protection mode.
2	Battery has no voltage output, but "POWER ON"/"POWER WAKE" LEDs are on.	The BDU relay is faulty.	Replace BDU.
3	When the battery is connected to the inverter, the DC breaker trips Instantly.	Short circuit between battery and inverter.	Check whether there is a short circuit between battery and inverter; Check if the inverter is faulty.
4	Communication failure between battery and inverter.	Wrong battery type is selected in the inverter settings.	Select the correct battery type in the inverter settings.

### Replacement of Main Components

#### Replacing the Battery Controller (BDU)

 **WARNING**

Turn off the entire battery system. Ensure that the negative and positive terminals are de-energized.

1. Switch the ON/OFF switch off.

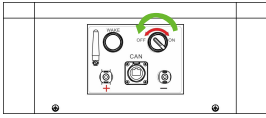

2. Switch the BDU DC BREAKER to OFF position.

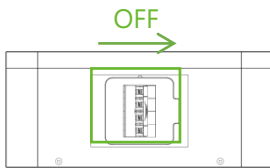

- Disconnect the connecting cable.
- Remove the four screws on the BDU and remove the BDU from the system.

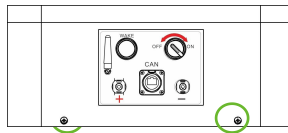

Figure 4-1 BDU right connections

- Exchange BDU. Then fix it with four screws.
- After replacing the new BDU, the battery self-test needs to be performed again (see Table 3-2 Battery system self-test).

### Battery Maintenance



**DANGER**

Battery maintenance should only be carried out by professional and authorized persons. Switch off the battery system before maintenance.

Voltage check:

[Periodical maintenance] Check the voltage of the battery system with the monitoring software. Check whether the system voltage is normal. For example: Check whether the single cell voltage is out of range.

Voltage check:

[Periodical maintenance] Check the SOC of the battery system with the monitoring software. Check whether the SOC of the batteries is normal.

Cable check:

[Periodical maintenance] Visually inspect all cables of the battery system. Check whether the cables are broken, aging or loose.

**Balancing:**

[Periodical maintenance] The battery system will become unbalanced if it has not been charged fully for a long time. Solution: Perform balancing maintenance (fully charge) every 3 month. Generally this maintenance progress needs to be completed when external devices such as the monitoring software and battery and inverter have proper communication.

**Output relay check:**

[Periodical maintenance] Under low load (low current), check the output relay OFF and ON condition; listen if the relay clicks, which means that it switches off and on normally.

## 5 Storage Recommendations

For long-term storage (more than 3 months), the battery cells should be stored in following environment: temperature range 5 to 45°C, relative humidity <65% and no corrosive gases.

The battery module should be placed in temperature range 5 to 45°C, dry, clean and well ventilated environment. The battery should be charged to 50 - 55% SOC before storage. We recommend activating the battery system (discharge and charge) every 3 months, and the longest storage duration without charge and discharge should not exceed 6 months.



The lifespan of the battery will be greatly reduced if you do not follow above instructions to store the battery for a long term.

## 6 Shipment

The battery module is pre-charged to 50% SOC or according to customer requirements before shipment. The remaining capacity of battery cells is determined by the storage time and condition after shipment.

The battery modules meet UN38.3 certificate standard.

In particular, special rules for the carriage of goods on the road and the current dangerous goods law, especially ADR (European Convention on the International Carriage of Dangerous Goods by Road), as amended, must be observed.



DISCOVER YOUR NATURE

Address: No. 511 Chenzhuang West Road, Sanshui Street,  
Jiangyan District, Taizhou City

Email: [service@dyness.com](mailto:service@dyness.com)

Tel: +86 400 666 0655

Web: [www.dyness.com](http://www.dyness.com)



Official Website



Digital version access